

# ML Maximum Power Point Tracking (MPPT) Series ML2420-ML2430-ML2440 Solar Charge and Discharge Controller

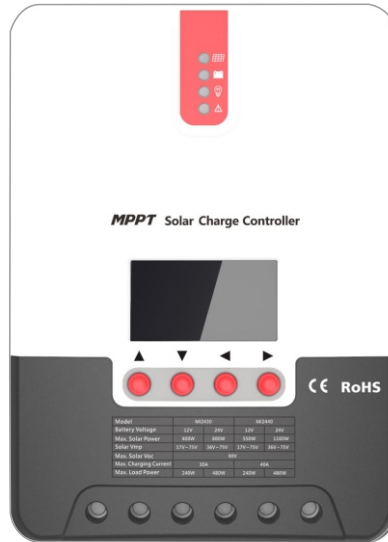

## Product Features

- With the advanced dual-peak or multi-peak tracking technology, when the solar panel is shadowed or part of the panel fails resulting in multiple peaks on the I-V curve, the controller is still able to accurately track the maximum power point.
- A built-in maximum power point tracking algorithm can significantly improve the energy utilization efficiency of photovoltaic systems, and raise the charging efficiency by 15% to 20% compared with the conventional PWM method.
- A combination of multiple tracking algorithms enables accurate tracking of the optimum working point on the I-V curve in an extremely short time.
- The product boasts an optimum MPPT tracking efficiency of up to 99.9%.
- Advanced digital power supply technologies raise the circuit's energy conversion efficiency to as high as 98%.
- Charging program options are available for different types of batteries including gel batteries, sealed batteries, open batteries, lithium batteries, etc.
- The controller features a limited current charging mode. When the solar panel power exceeds a certain level and the charging current is larger than the rated current, the controller will automatically lower the charging power and bring the charging current to the rated level.
- Instantaneous large current startup of capacitive loads is supported.
- Automatic recognition of battery voltage is supported.
- LED fault indicators and an LCD screen which can display abnormality information help users to quickly identify system faults.
- Historical data storage function is available, and data can be stored for up to a year.
- The controller is equipped with an LCD screen with which users can not only check device operating data and statuses, but also modify controller parameters.
- The controller supports standard Modbus protocol, fulfilling the communication needs of various occasions.
- The controller employs a built-in over-temperature protection mechanism. When temperature surpasses the set value, the charging current will decline in linear proportion to the temperature so as to curb the temperature rise of the controller, effectively keeping the controller from being damaged by overheat.
- Featuring a temperature compensation function, the controller can automatically adjust charging and discharging parameters in order to extend the battery's service life.
- TVS lightning protection.

Wiring diagram is as below

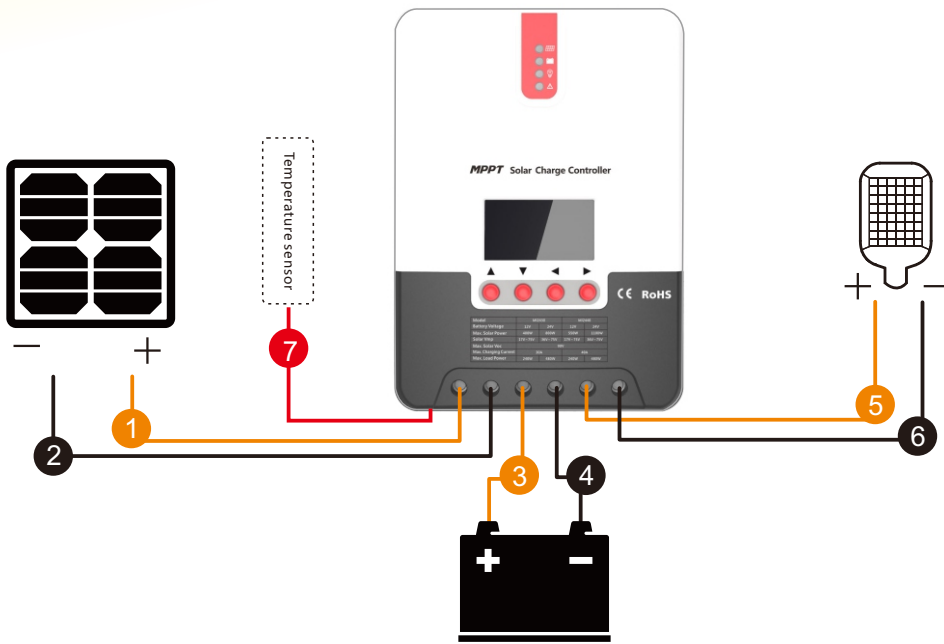



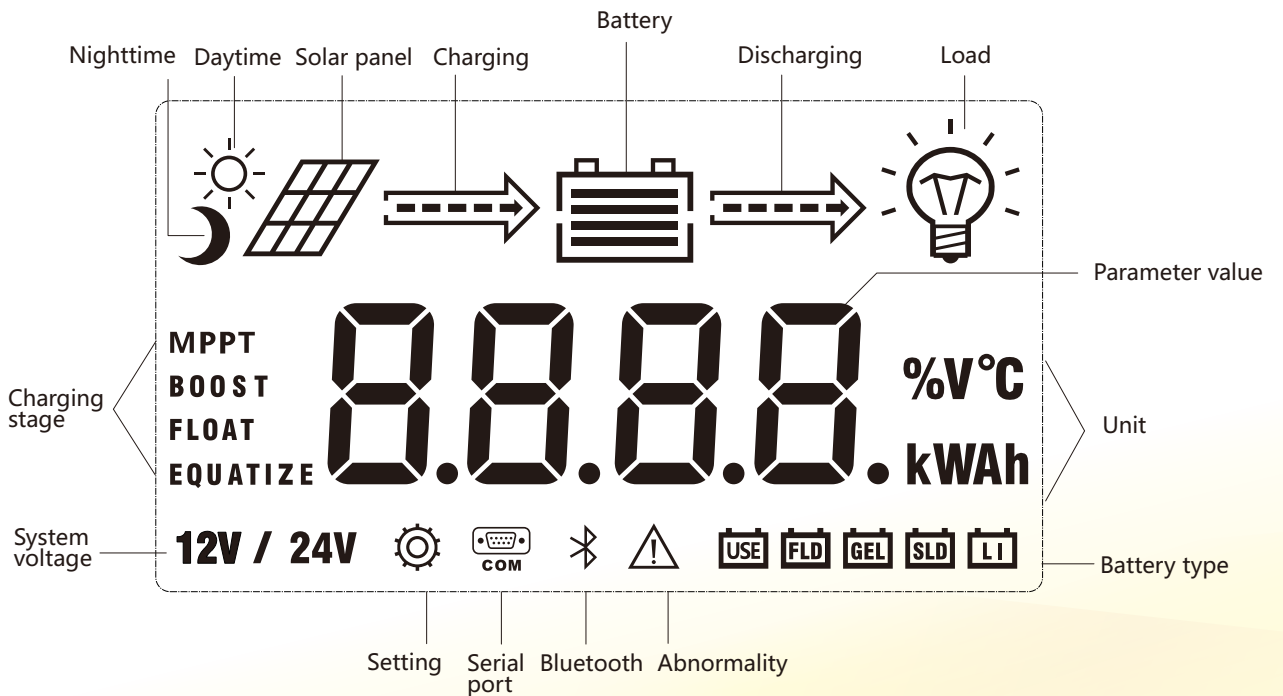





### LCD Startup and Main Interface







# Product Operation and Display

## LED Indicators

		PV array indicator	Indicating the controller's current charging mode.
		BAT indicator	Indicating the battery's current state.
		LOAD indicator	Indicating the loads' On/ Off and state.
		ERROR indicator	Indicating whether the controller is functioning normally.

### ➤ PV array indicator:

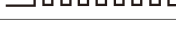
No.	Graph	Indicator state	Charging state
①	 BULK	Steady on	MPPT charging
②	 ACCEPTANCE	Slow flashing (a cycle of 2s with on and off each lasting for 1s)	Boost charging
③	 FLOAT	Single flashing (a cycle of 2s with on and off lasting respectively for 0.1s and 1.9s)	Floating charging
④	 EQUALIZE	Quick flashing (a cycle of 0.2s with on and off each lasting for 0.1s)	Equalizing charging
⑤	 CURRENT-LIMITED	Double flashing (a cycle of 2s with on for 0.1s, off for 0.1s, on again for 0.1s, and off again for 1.7s)	Current-limited charging
⑥		Off	No charging

### ➤ BAT indicator:

Indicator state	Battery state
Steady on	Normal battery voltage
Slow flashing (a cycle of 2s with on and off each lasting for 1s)	Battery over-discharged
Quick flashing (a cycle of 0.2s with on and off each lasting for 0.1s)	Battery over-voltage





### ➤ LOAD indicator:

Indicator state	Battery state
Off	Load turned off
Quick flashing (a cycle of 0.2s with on and off each lasting for 0.1s)	Load overloaded/ short-circuited
Steady on	Load functioning normally

### ➤ ERROR indicator:

Indicator state	Battery state
Off	System operating normally
Steady on	System malfunctioning

## Key Operations

	Up	Page up; increase the parameter value in setting
	Down	Page down; decrease the parameter value in setting
	Return	Return to previous menu (exit without saving)
	Set	Enter into sub-menu; set/ save Turn on/ off loads (in manual mode)

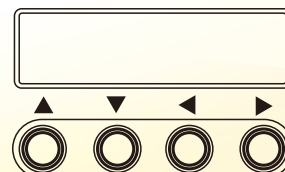

# Product Dimensions

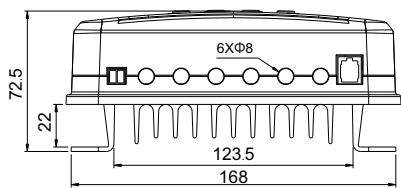
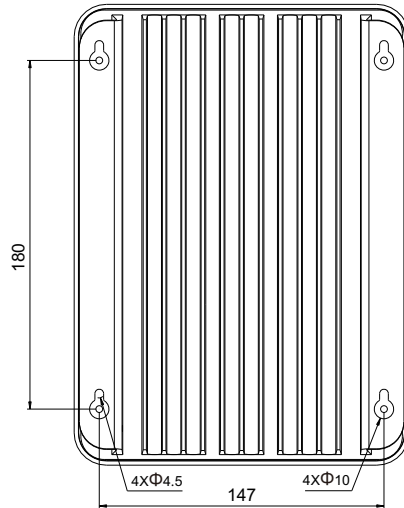
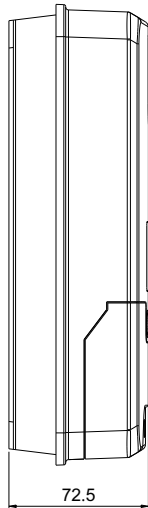
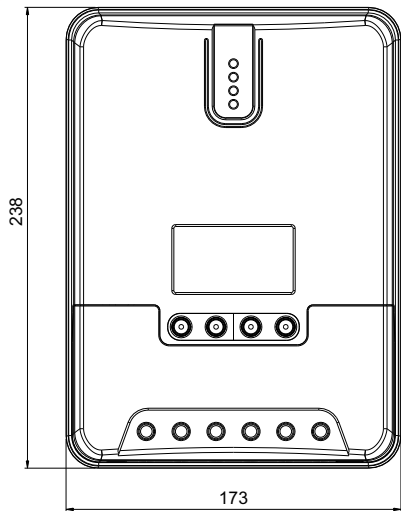

**ML2430/ML2440**  
 Product dimensions : 238\*173\*72.5mm  
 Hole positions : 180\*147mm  
 Hole diameter : Φ3mm  
 Applicable wire: max. 8 AWG

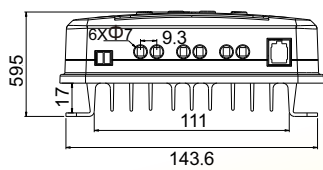
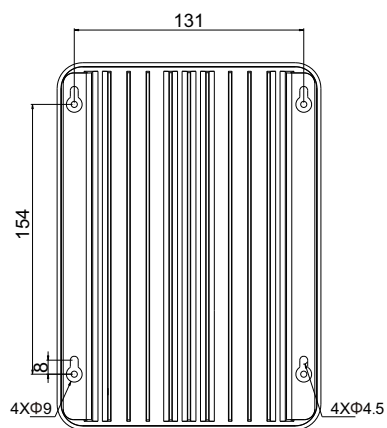
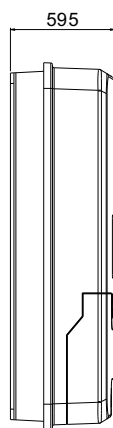
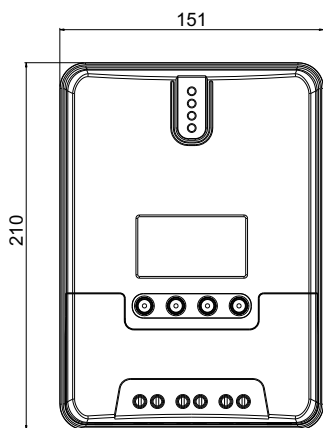

**ML2420**  
 Product dimensions : 210\*151\*59.5mm  
 Hole positions : 154\*131mm  
 Hole diameter : Φ3mm  
 Applicable wire: max. 8 AWG

# Product Specification Parameters

## 1. Electric Parameters

Parameter	Value		
Model	ML2420	ML2430	ML2440
System voltage	12V/24VAuto		
No-load loss	0.7 W to 1.2W		
Battery voltage	9V to 35V		
Max. solar input voltage	100V(25°C) 90V(-25°C)		
Max. power point voltage range	Battery Voltage+2V to 75V		
Rated charging current	20A	30A	40A
Rated load current	20A		
Max. capacitive load capacity	10000uF		
Max. photovoltaic system input power	260W/12V 520W/24V	400W/12V 800W/24V	520W/12V 1040W/24V
Conversion efficiency	≤98%		
MPPT tracking efficiency	>99%		
Temperature compensation factor	-3mv/°C/2V ( default )		
Operating temperature	-35°C to +45°C		
Protection degree	IP32		
Weight	1.4Kg	2Kg	2Kg
Communication method	RS232		
Altitude	≤ 3000m		
Product dimensions	210*151*59.5mm	238*173*72.5mm	238*173*72.5mm

## 2. Battery Type Default

**Parameters** (parameters set in monitor software)

Parameters cross-reference table for different types of batteries				
Voltage to set Battery type	Sealed lead-acid battery	Gel lead-acid battery	Open lead-acid battery	User (self-customized)
Over-voltage cut-off voltage	16.0V	16.0V	16.0V	9~17V
Equalizing voltage	14.6V	—	14.8V	9~17V
Boost voltage	14.4V	14.2V	14.6V	9~17V
Floating charging voltage	13.8V	13.8V	13.8V	9~17V
Boost return voltage	13.2V	13.2V	13.2V	9~17V
Low-voltage cut-off return voltage	12.6V	12.6V	12.6V	9~17V
Under-voltage warning return voltage	12.2V	12.2V	12.2V	9~17V
Under-voltage warning voltage	12.0V	12.0V	12.0V	9~17V
Low-voltage cut-off voltage	11.1V	11.1V	11.1V	9~17V
Discharging limit voltage	10.6V	10.6V	10.6V	9~17V
Over-discharge time delay	5s	5s	5s	1~30s
Equalizing charging duration	120minutes	—	120minutes	0~600minutes
Equalizing charging interval	30days	0days	30days	0~250D (0 means the equalizing charging function is disabled)
Boost charging duration	120minutes	120minutes	120minutes	10~600minutes

When selecting User, the battery type is to be self-customized, and in this case, the default system voltage parameters are consistent with those of the sealed lead-acid battery. When modifying battery charging and discharging parameters, the following rule must be followed:

- Over-voltage cut-off voltage > Charging limit voltage ≥ Equalizing voltage ≥ Boost voltage ≥ Floating charging voltage > Boost return voltage;
- Over-voltage cut-off voltage > Over-voltage cut-off return voltage;
- Low-voltage cut-off return voltage > Low-voltage cut-off voltage ≥ Discharging limit voltage;
- Under-voltage warning return voltage > Under-voltage warning voltage ≥ Discharging limit voltage;
- Boost return voltage > Low-voltage cut-off return voltage.

# Product Details

